

## FURNITURE OVERVIEW



C-frame laboratory benches



Fume Hood      Chemical Storage Cabinet      Laboratory Rack      Biosafety Cabinet



**Corporate Head Office:**  
12, Chris Akinro Close, Off Agungi Road,  
Agungi, Lekki Lagos, Nigeria.  
**Factory:**  
Km 26, Lekki-Epe Expressway, Onosa Village,  
Via Igando Oloja, Ibeju-Lekki, Lagos, Nigeria



**Chibek Instruments Limited**  
**Tel:** 01-4408333, 09025348479,  
08150482161, 08064770494, 09099252235  
**E-mail:** sales@chibek.com  
**Website:** www.chibek.com



## ALL STEEL LAB BENCH



C-Frame



Mobile Unit Cabinet



### ALL STEEL LAB BENCH

It's designed by CAD and digital-precision made. As a single unit, it can be assembled with a better formation to fit into your lab space. It's with good weight bearing, long lifetime and excellent cost performance. It can meet your space requirement for laboratory.

The workstation body is using selected 1.0mm thickness first-class cold/galvanised steel sheet, automatic skimmers forming, phosphating and picking treatment for surface, epoxy resin powder, no prominent section block, smooth charm, outstanding acid-proof and alkali-proof performance.

Worktop can choose lab-grade phenolic resin, Trespa, epoxy resin, ceramics etc. exclusive table materials.



**Corporate Head Office:**  
12, Chris Akinro Close, Off Agungi Road,  
Agungi, Lekki Lagos, Nigeria.  
**Factory:**  
Km 26, Lekki-Epe Expressway, Onosa Village,  
Via Igando Oloja, Ibeju-Lekki, Lagos, Nigeria



**Chibek Instruments Limited**  
**Tel:** 01-4408333, 09025348479,  
08150482161, 08064770494, 09099252235  
**E-mail:** sales@chibek.com  
**Website:** www.chibek.com



# ALL STEEL LAB BENCH



**Corporate Head Office:**  
12, Chris Akinro Close, Off Agungi Road,  
Agungi, Lekki Lagos, Nigeria.  
**Factory:**  
Km 26, Lekki-Epe Expressway, Onosa Village,  
Via Igando Oloja, Ibeju-Lekki, Lagos, Nigeria



**Chibek Instruments Limited**  
**Tel:** 01-4408333, 09025348479,  
08150482161, 08064770494, 09099252235  
**E-mail:** sales@chibek.com  
**Website:** www.chibek.com



## ALL STEEL LAB BENCH

C-Frame

The benches are available with

- other dimensions
- different workshops
- alternative cabinet fronts and underbench cabinet bases as well as accessories on requisition.

The benches are available with

- other dimensions
- different workshops
- alternative cabinet fronts and underbench cabinet bases as well as accessories on requisition.



**Corporate Head Office:**  
12, Chris Akinro Close, Off Agungi Road,  
Agungi, Lekki Lagos, Nigeria.  
**Factory:**  
Km 26, Lekki-Epe Expressway, Onosa Village,  
Via Igando Oloja, Ibeju-Lekki, Lagos, Nigeria



**Chibek Instruments Limited**  
**Tel:** 01-4408333, 09025348479,  
08150482161, 08064770494, 09099252235  
**E-mail:** sales@chibek.com  
**Website:** www.chibek.com



## STEEL AND WOOD LAB BENCH



C-Frame

The benches are available with

- other dimensions
- different workshops
- alternative cabinet fronts and underbench cabinet bases as well as accessories on requisition.



**Corporate Head Office:**  
12, Chris Akinro Close, Off Agungi Road,  
Agungi, Lekki Lagos, Nigeria.  
**Factory:**  
Km 26, Lekki-Epe Expressway, Onosa Village,  
Via Igando Oloja, Ibeju-Lekki, Lagos, Nigeria



**Chibek Instruments Limited**  
**Tel:** 01-4408333, 09025348479,  
08150482161, 08064770494, 09099252235  
**E-mail:** sales@chibek.com  
**Website:** www.chibek.com



## STEEL AND WOOD LAB BENCH



C-Frame

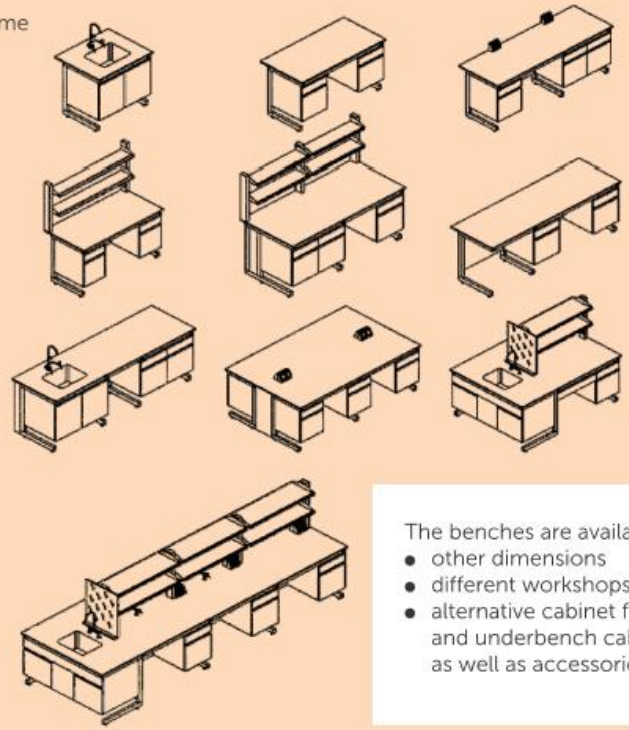

The benches are available with

- other dimensions
- different workshops
- alternative cabinet fronts and underbench cabinet bases as well as accessories on requisition.



**Corporate Head Office:**  
12, Chris Akinro Close, Off Agungi Road,  
Agungi, Lekki Lagos, Nigeria.  
**Factory:**  
Km 26, Lekki-Epe Expressway, Onosa Village,  
Via Igando Oloja, Ibeju-Lekki, Lagos, Nigeria



**Chibek Instruments Limited**  
**Tel:** 01-4408333, 09025348479,  
08150482161, 08064770494, 09099252235  
**E-mail:** sales@chibek.com  
**Website:** www.chibek.com



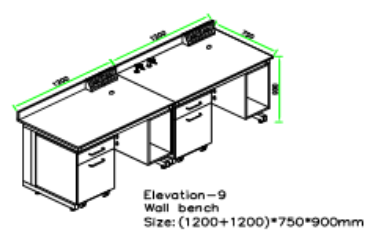
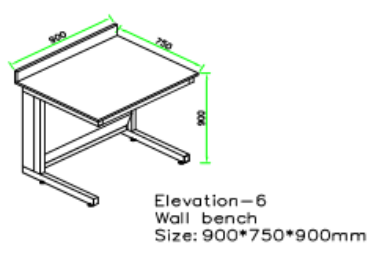
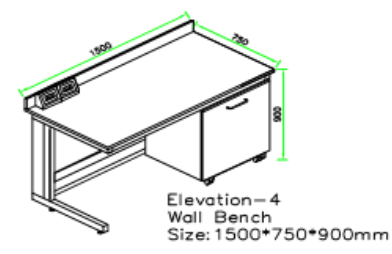
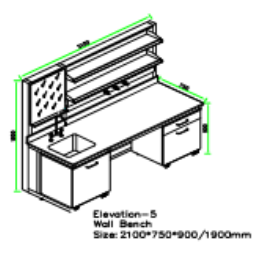
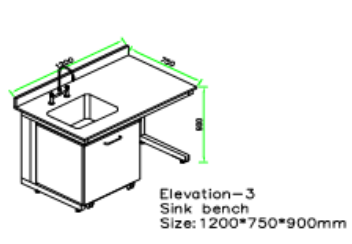
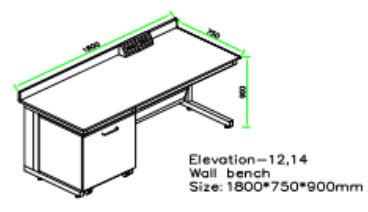
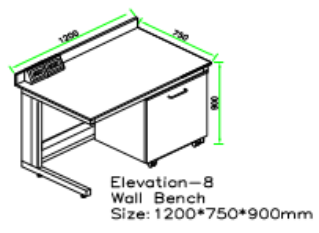
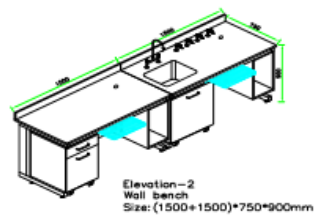
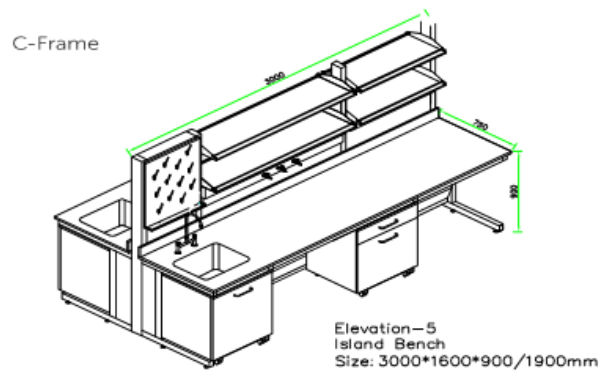

**Corporate Head Office:**  
12, Chris Akinro Close, Off Agungi Road,  
Agungi, Lekki Lagos, Nigeria.  
**Factory:**  
Km 26, Lekki-Epe Expressway, Onosa Village,  
Via Igando Oloja, Ibeju-Lekki, Lagos, Nigeria



**Chibek Instruments Limited**  
**Tel:** 01-4408333, 09025348479,  
08150482161, 08064770494, 09099252235  
**E-mail:** sales@chibek.com  
**Website:** www.chibek.com



H-Frame



H-frame Wall Cabinet

**H-Frame**  
 The Steel & Wood lab bench includes two kinds of structure. H-frame works better with heavy bearing.  
 It selects 40x60/30x30mm square steel, phosphating and pickling treatment surface, epoxy resin powder paint, no prominent section-block, smooth charm, outstanding acid-proof and alkali-proof performance.  
 Stainless steel and rubber adjustable feet. It's damping-proof, corrosive-proof. It's with shock absorbing function and with better weight bearing. The adjustable height is 30-50mm and its bearing capacity can reach above 150KG.  
 Steel H-frame can meet the requirements of using large-scale precision and can hold more than 500KG weight.  
 Worktop can choose lab-grade phenolic resin, Trespa, epoxy resin, ceramic etc exclusive table material.



**Corporate Head Office:**  
 12, Chris Akinro Close, Off Agungi Road,  
 Agungi, Lekki Lagos, Nigeria.  
**Factory:**  
 Km 26, Lekki-Epe Expressway, Onosa Village,  
 Via Igando Oloja, Ibeju-Lekki, Lagos, Nigeria



**Chibek Instruments Limited**  
**Tel:** 01-4408333, 09025348479,  
 08150482161, 08064770494, 09099252235  
**E-mail:** sales@chibek.com  
**Website:** www.chibek.com



## STEEL AND WOOD LAB BENCH



H-Frame

- other dimensions
- different workshops
- alternative cabinet fronts and underbench cabinet bases as well as accessories on requisition.



**Corporate Head Office:**  
12, Chris Akinro Close, Off Agungi Road,  
Agungi, Lekki Lagos, Nigeria.  
**Factory:**  
Km 26, Lekki-Epe Expressway, Onosa Village,  
Via Igando Oloja, Ibeju-Lekki, Lagos, Nigeria



**Chibek Instruments Limited**  
**Tel:** 01-4408333, 09025348479,  
08150482161, 08064770494, 09099252235  
**E-mail:** sales@chibek.com  
**Website:** www.chibek.com



DESCRIPTION
<b>Island benches, both sink and plain benches</b>
<p>WorkTop:19mm thickness Epoxy resin. color is black. Support frame :60*40*2mm thick. Galvanized steel tube frame with epoxy power coated. Handles:128mm 304 stainless steel handle, Slide way: three section slide rails, no noise, Movable Cabinet Body: made from 1.0mm cold rolled steel, the doors have sound absorbing material. keeps noise, to a minimum when opening and closing. Hinge: 304 stainless steel hydraulic hinge.</p> <p>100mm high back splash, include 1 epoxy-resin sink, size is 460*400*260mm,1 triple outlet water faucet (White worktop, light blue for doors, light gray for body).</p>



SIZES
<p>3000x1500x900/1650mm            3000x750x900/1650mm            2100x1500x900/1650mm            2100x750x900/1650mm.            Customized Sizes to Customers need</p>



**Corporate Head Office:**  
 12, Chris Akinro Close, Off Agungi Road,  
 Agungi, Lekki Lagos, Nigeria.  
**Factory:**  
 Km 26, Lekki-Epe Expressway, Onosa Village,  
 Via Igando Oloja, Ibeju-Lekki, Lagos, Nigeria



**Chibek Instruments Limited**  
**Tel:** 01-4408333, 09025348479,  
 08150482161, 08064770494, 09099252235  
**E-mail:** sales@chibek.com  
**Website:** www.chibek.com





**Corporate Head Office:**  
12, Chris Akinro Close, Off Agungi Road,  
Agungi, Lekki Lagos, Nigeria.  
**Factory:**  
Km 26, Lekki-Epe Expressway, Onosa Village,  
Via Igando Oloja, Ibeju-Lekki, Lagos, Nigeria



**Chibek Instruments Limited**  
**Tel:** 01-4408333, 09025348479,  
08150482161, 08064770494, 09099252235  
**E-mail:** sales@chibek.com  
**Website:** www.chibek.com



DESCRIPTION
<b>STANDARD WORKBENCH:</b>
Standard workbenches have elegant appearance with L shape table legs, worldwide popular design and standard workbench are height adjustable in manual and motorized version.



DTA 101



DTA 102

<b>SIZES</b>
3000*750*900/1450mm 2100*750*900/1650mm 1530*750*900/1650mm 900*750*900mm 750*750*900/1450mm 2100*750*900/1650mm 1530*750*900/1650mm Customized Sizes to Customers need



**Corporate Head Office:**  
12, Chris Akinro Close, Off Agungi Road,  
Agungi, Lekki Lagos, Nigeria.  
**Factory:**  
Km 26, Lekki-Epe Expressway, Onosa Village,  
Via Igando Oloja, Ibeju-Lekki, Lagos, Nigeria



**Chibek Instruments Limited**  
**Tel:** 01-4408333, 09025348479,  
08150482161, 08064770494, 09099252235  
**E-mail:** sales@chibek.com  
**Website:** www.chibek.com





DTA116



DTA 107



CUSTOME DESIGN LAB CONFIGURATION



ISLAND SINK BENCH



ISLAND PLAIN BENCH



**Corporate Head Office:**  
12, Chris Akinro Close, Off Agungi Road,  
Agungi, Lekki Lagos, Nigeria.  
**Factory:**  
Km 26, Lekki-Epe Expressway, Onosa Village,  
Via Igando Oloja, Ibeju-Lekki, Lagos, Nigeria



**Chibek Instruments Limited**  
**Tel:** 01-4408333, 09025348479,  
08150482161, 08064770494, 09099252235  
**E-mail:** sales@chibek.com  
**Website:** www.chibek.com



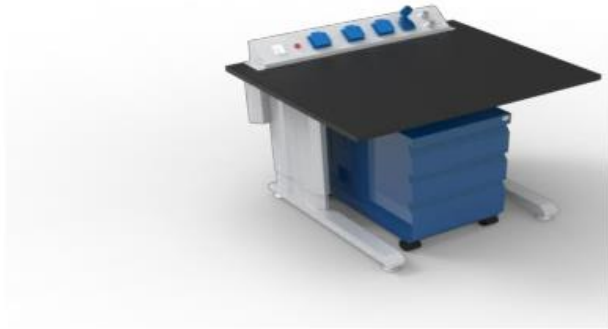

WALL BENCH



CUSTOM DESIGN LAB CONFIGURATION



**Corporate Head Office:**  
12, Chris Akinro Close, Off Agungi Road,  
Agungi, Lekki Lagos, Nigeria.  
**Factory:**  
Km 26, Lekki-Epe Expressway, Onosa Village,  
Via Igando Oloja, Ibeju-Lekki, Lagos, Nigeria



**Chibek Instruments Limited**  
**Tel:** 01-4408333, 09025348479,  
08150482161, 08064770494, 09099252235  
**E-mail:** sales@chibek.com  
**Website:** www.chibek.com



DESCRIPTION
<b>INDUSTRIAL WORKBENCH:</b>
It uses cold rolled steel with thickness 2.0mm, weight loading: 1000-2000KG



DTA138



DTA137



DTA139



DTA141



DTA141

<p><b>SIZES</b></p> <p>3000*750*900/1450mm                  2100*750*900/1650mm                  1530*750*900/1650mm                  900*750*900mm                  750*750*900/1450mm                  2100*750*900/1650mm                  1530*750*900/1650mm                  Customized Sizes to Customers need.</p>
--



**Corporate Head Office:**  
 12, Chris Akinro Close, Off Agungi Road,  
 Agungi, Lekki Lagos, Nigeria.  
**Factory:**  
 Km 26, Lekki-Epe Expressway, Onosa Village,  
 Via Igando Oloja, Ibeju-Lekki, Lagos, Nigeria



**Chibek Instruments Limited**  
**Tel:** 01-4408333, 09025348479,  
 08150482161, 08064770494, 09099252235  
**E-mail:** sales@chibek.com  
**Website:** www.chibek.com



DESCRIPTION
<b>INDUSTRIAL WORKBENCH:</b>
It uses cold rolled steel with thickness 2.0mm, weight loading: 1000-2000KG



DTA122

DTA124



CUSTOM DESIGN LAB CONFIGURATION

<b>SIZES</b>
Customized Sizes to Customers need.



**Corporate Head Office:**  
12, Chris Akinro Close, Off Agungi Road,  
Agungi, Lekki Lagos, Nigeria.  
**Factory:**  
Km 26, Lekki-Epe Expressway, Onosa Village,  
Via Igando Oloja, Ibeju-Lekki, Lagos, Nigeria



**Chibek Instruments Limited**  
**Tel:** 01-4408333, 09025348479,  
08150482161, 08064770494, 09099252235  
**E-mail:** sales@chibek.com  
**Website:** www.chibek.com



DESCRIPTION
<b>LABORATORY ACCESSORIES:</b>
Modular accessories help customer to get a flexible workbench configuration according to their own need. The modular accessories can offer economic option to add accessories in the future. It can also offer a flexible price depending on your selection.



ANTISTATIC MOVABLE CABINET



ANTISTATIC MOVABLE CABINET



ANTISTATIC MOVABLE CABINET



CONTAINER STORE CABINET



**Corporate Head Office:**  
12, Chris Akinro Close, Off Agungi Road,  
Agungi, Lekki Lagos, Nigeria.  
**Factory:**  
Km 26, Lekki-Epe Expressway, Onosa Village,  
Via Igando Oloja, Ibeju-Lekki, Lagos, Nigeria



**Chibek Instruments Limited**  
**Tel:** 01-4408333, 09025348479,  
08150482161, 08064770494, 09099252235  
**E-mail:** sales@chibek.com  
**Website:** www.chibek.com





MONITOR SHELF



ANTISTATIC MOVABLE CABINET



**Corporate Head Office:**  
12, Chris Akinro Close, Off Agungi Road,  
Agungi, Lekki Lagos, Nigeria.  
**Factory:**  
Km 26, Lekki-Epe Expressway, Onosa Village,  
Via Igando Oloja, Ibeju-Lekki, Lagos, Nigeria



**Chibek Instruments Limited**  
**Tel:** 01-4408333, 09025348479,  
08150482161, 08064770494, 09099252235  
**E-mail:** sales@chibek.com  
**Website:** www.chibek.com





M UPRIGHT FRAME



ANTISTATIC ADJUSTABLE SHELF



**Corporate Head Office:**  
12, Chris Akinro Close, Off Agungi Road,  
Agungi, Lekki Lagos, Nigeria.  
**Factory:**  
Km 26, Lekki-Epe Expressway, Onosa Village,  
Via Igando Oloja, Ibeju-Lekki, Lagos, Nigeria



**Chibek Instruments Limited**  
**Tel:** 01-4408333, 09025348479,  
08150482161, 08064770494, 09099252235  
**E-mail:** sales@chibek.com  
**Website:** www.chibek.com



LABORATORY FURNITURE



**Corporate Head Office:**  
 12, Chris Akinro Close, Off Agungi Road,  
 Agungi, Lekki Lagos, Nigeria.  
**Factory:**  
 Km 26, Lekki-Epe Expressway, Onosa Village,  
 Via Igando Oloja, Ibeju-Lekki, Lagos, Nigeria



**Chibek Instruments Limited**  
**Tel:** 01-4408333, 09025348479,  
 08150482161, 08064770494, 09099252235  
**E-mail:** sales@chibek.com  
**Website:** www.chibek.com



## REFERENCES

- Standard Organization of Nigeria (SON) laboratory complex, Ikeja, Lagos (Supply and Installation of Modular lab furniture and fume hood - index 1)
- University of Ibadan Chemistry department laboratory, Ibadan, Oyo state. (Supply and Installation of Modular lab furniture and fume hood - index 1)
- GEM laboratories, GRA, Onitsha, Anambra state (Supply and Installation of Modular lab furniture and lamina flow - index 1)
- Port-Harcourt Refinery Company, Eleme, Port-Harcourt (Design of water lab & general testing lab in view of supplying and installation of Modular lab furniture, lamina flow & fume hood - index 2)

## INDEX - 1

### MICROBIOLOGY LAB - SON



**Corporate Head Office:**  
12, Chris Akinro Close, Off Agungi Road,  
Agungi, Lekki Lagos, Nigeria.  
**Factory:**  
Km 26, Lekki-Epe Expressway, Onosa Village,  
Via Igando Oloja, Ibeju-Lekki, Lagos, Nigeria



**Chibek Instruments Limited**  
**Tel:** 01-4408333, 09025348479,  
08150482161, 08064770494, 09099252235  
**E-mail:** sales@chibek.com  
**Website:** www.chibek.com



**CEMENT LABORATORY - SON**



**MICRONUTRIENT LAB - SON**



**CHEMISTRY LAB - UI**



**Corporate Head Office:**  
12, Chris Akinro Close, Off Agungi Road,  
Agungi, Lekki Lagos, Nigeria.  
**Factory:**  
Km 26, Lekki-Epe Expressway, Onosa Village,  
Via Igando Oloja, Ibeju-Lekki, Lagos, Nigeria



**Chibek Instruments Limited**  
**Tel:** 01-4408333, 09025348479,  
08150482161, 08064770494, 09099252235  
**E-mail:** sales@chibek.com  
**Website:** www.chibek.com

